

Design Mirror Looka

Installation Manual

Contents

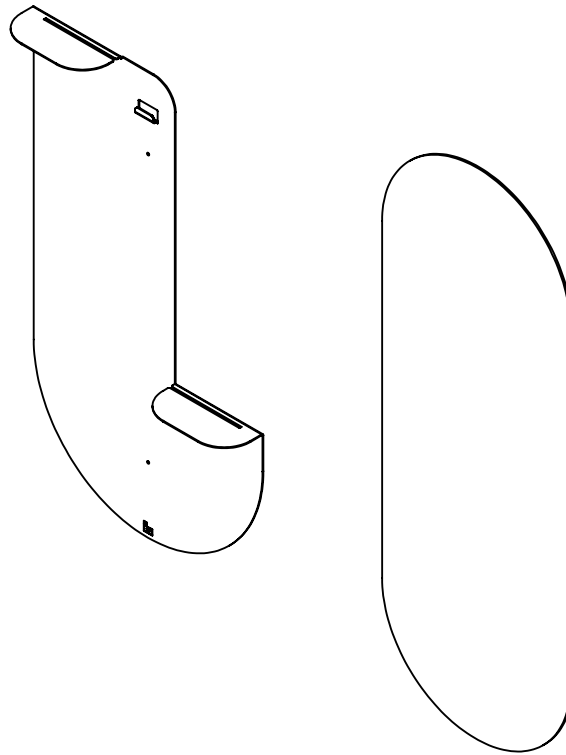

2st  Screw

1st  Magnet

2st  Plug

Supplies

- Pencil
- Level
- Impact drill
- Masonry drill $\text{\O}6\text{mm}$
- Screwdriver

01| Positioning

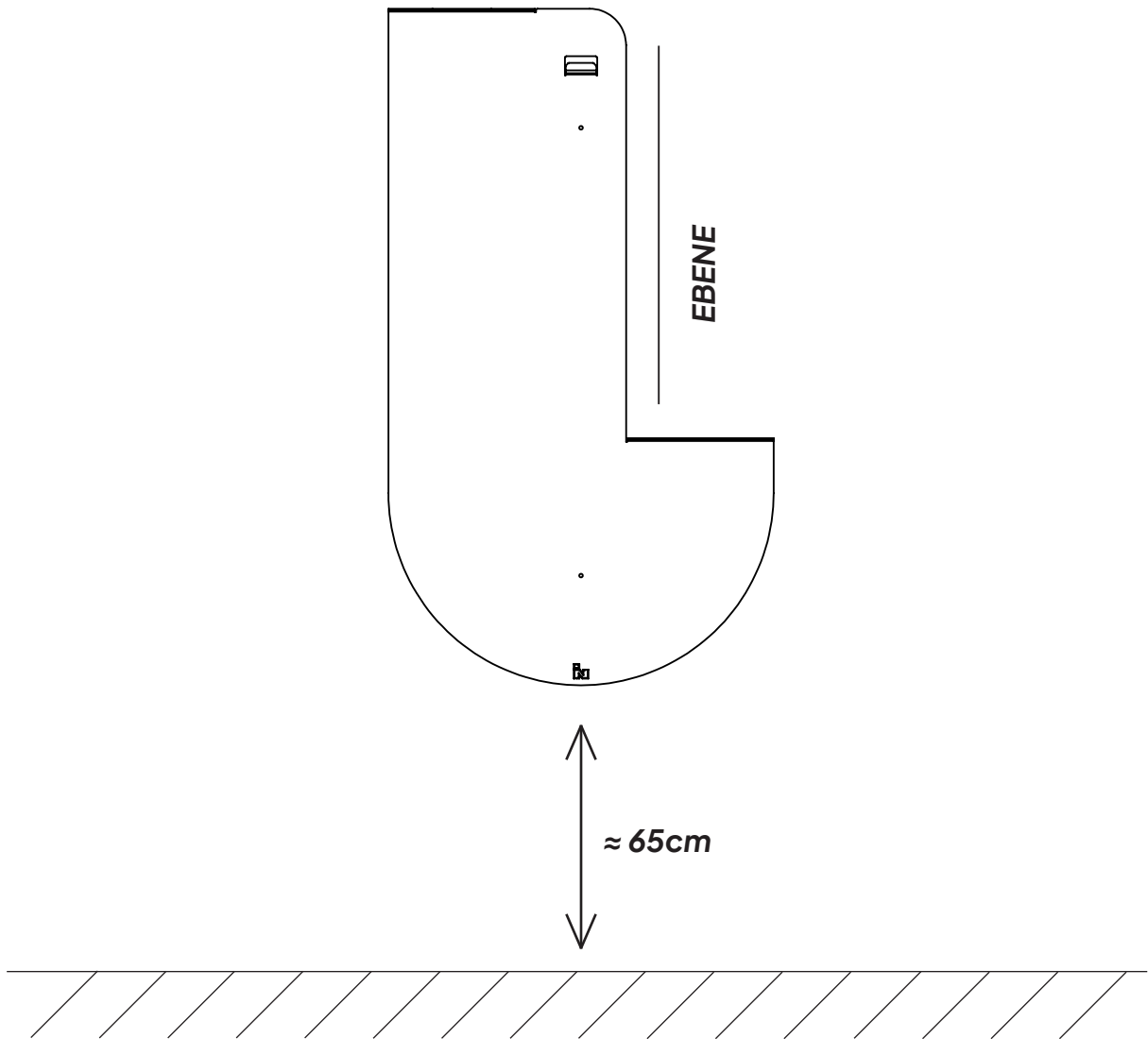

1. Position the steel base at the desired location on the wall. Make sure the line, as shown in the drawing, is level.
2. Mark the holes.
3. Remove the steel from the wall and pre-drill the marked holes with a 6mm (stone) drill.

02| Plugs

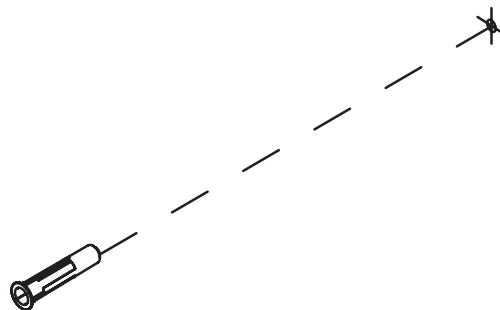
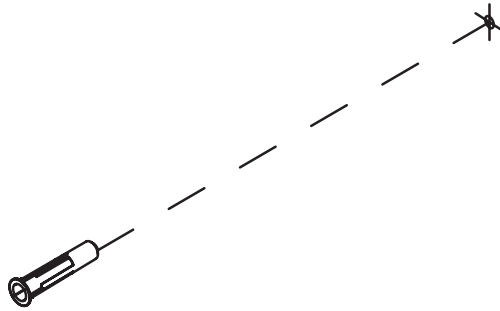

-
4. Place the supplied plugs in the pre-drilled holes.

03| Attachment

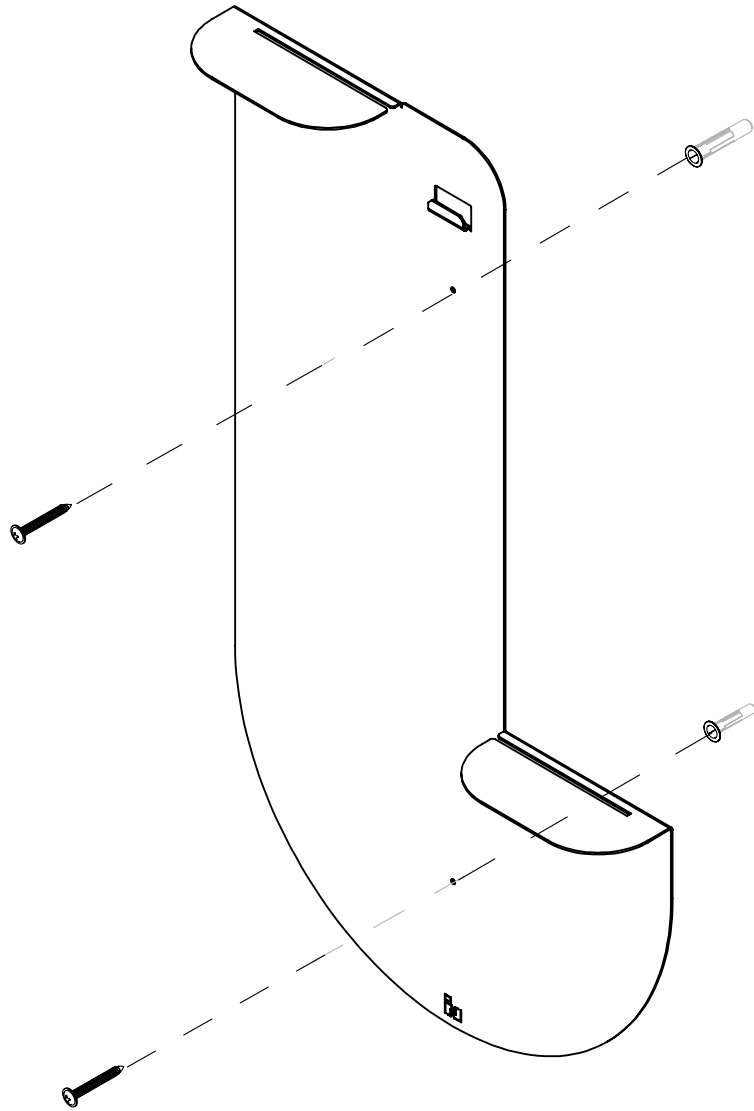

-
5. Attach the steel base to the wall with the supplied screws.

04| Install mirror

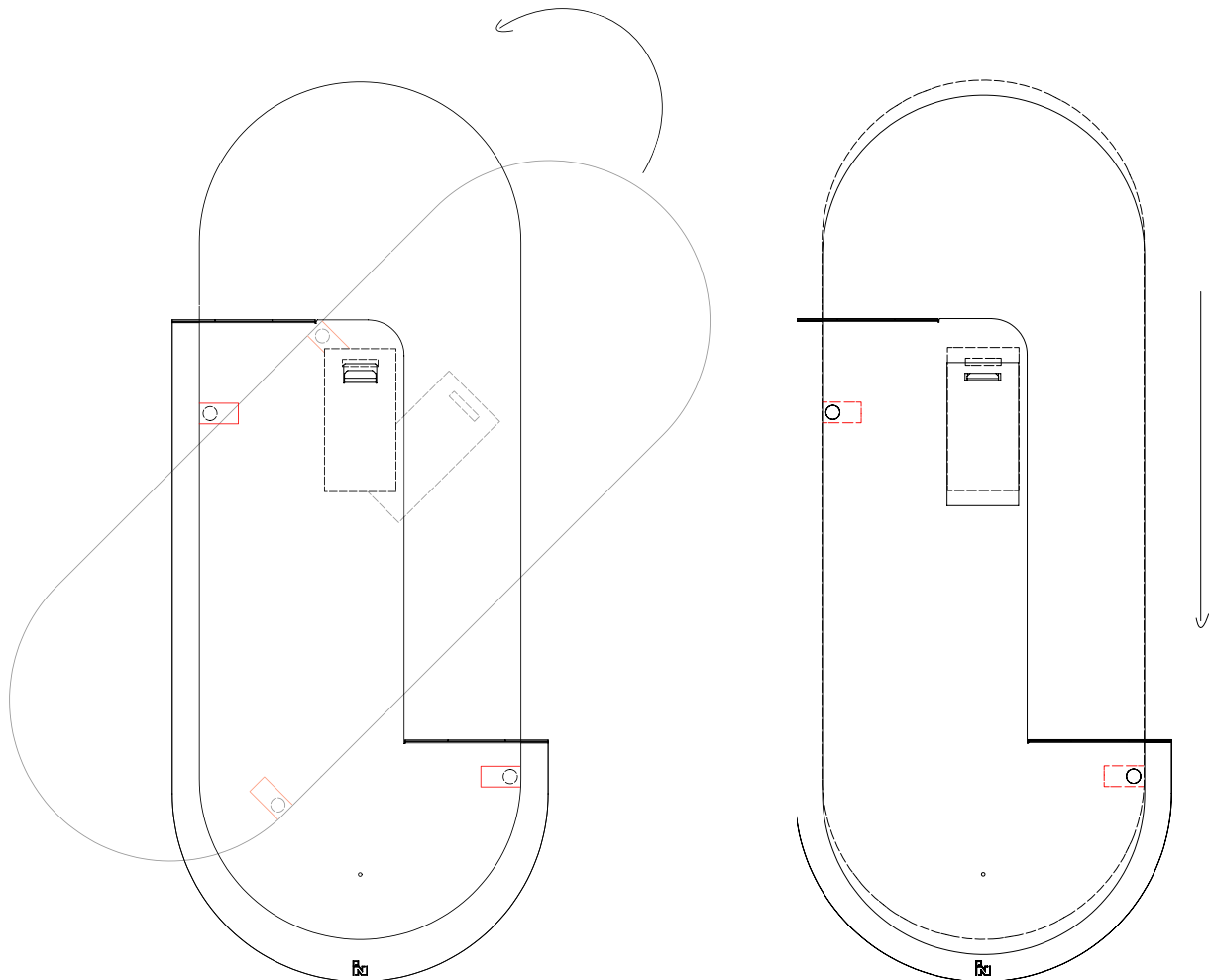

6. Tilt the mirror and place it into the slots. Continue until the mirror is upright. NB! Make sure that the two positioning stickers remain just below the two shelves. See red marking.
7. Lower the mirror onto the mounting plate.

05| Placement magnets

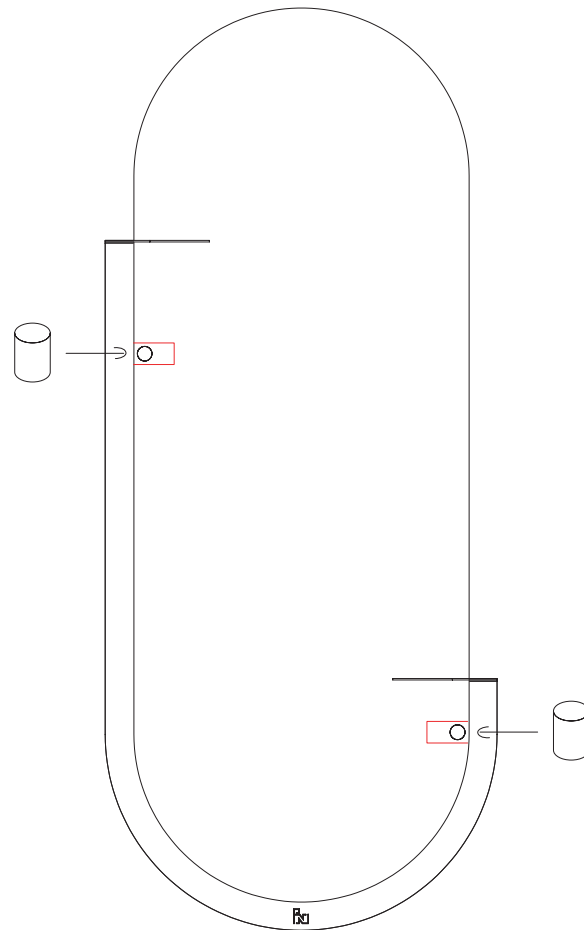

-
8. Place the two magnets next to the marking and press them behind the mirror.
 9. Remove the tape.

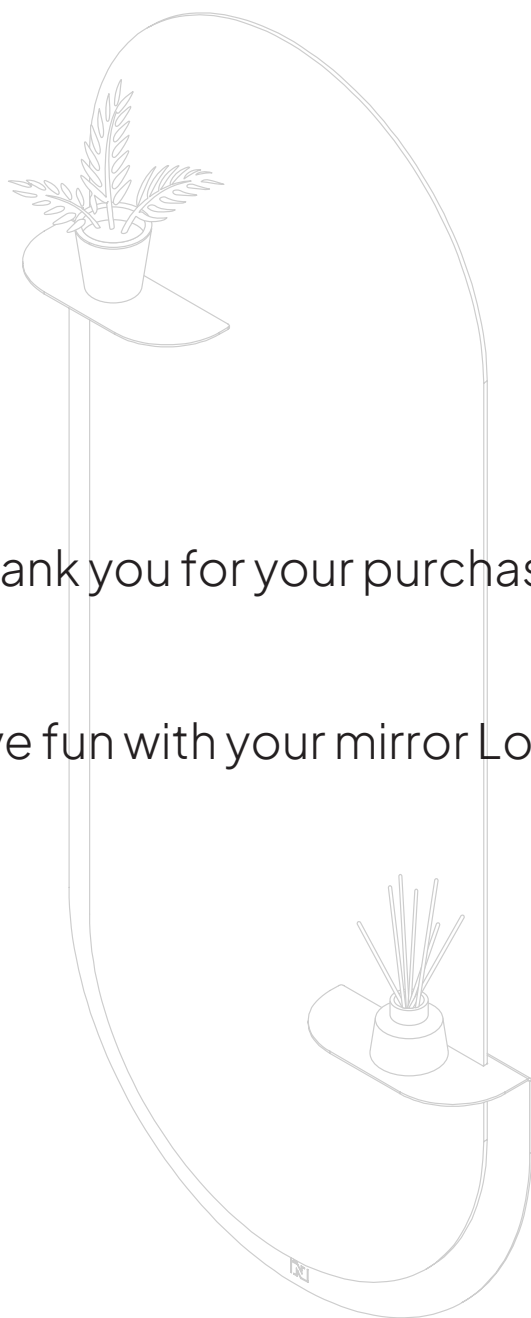

Thank you for your purchase!

Have fun with your mirror Looka

Indusigns

van ontwerp tot realisatie